

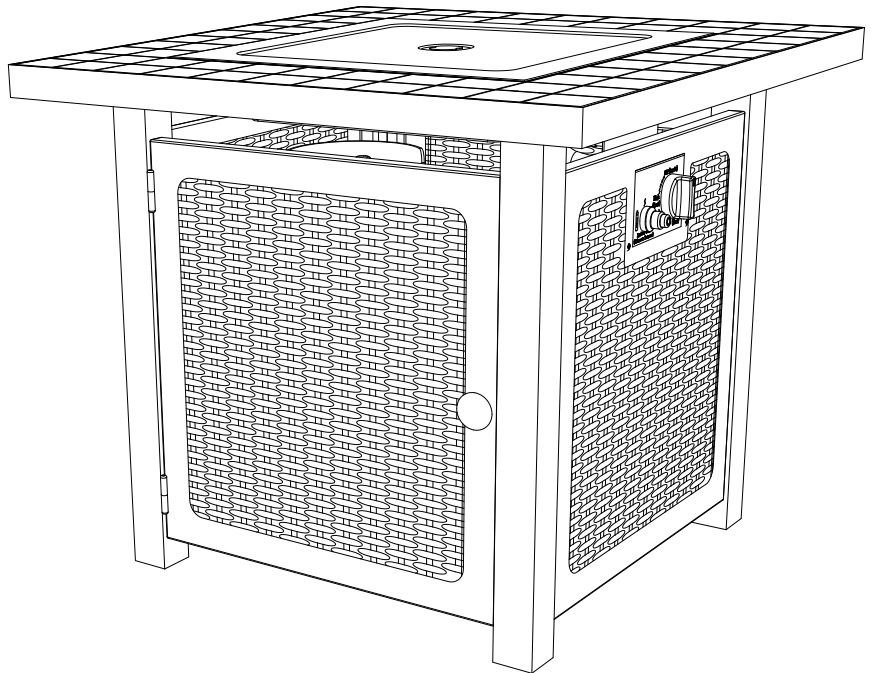

# OWNER'S MANUAL

PATIO HEATER

MODEL # GFT-68043



**Precaution!**

The Powder Coating paint process has become the most common widely used application in the outdoor furniture category. Unfortunately powder coating is extremely sensitive to Humidity and Moisture. A simple process to protect your furniture, especially flat surfaces is to apply a simple coat of good quality car wax prior to using. If this process is done every few months it will protect your furniture for years to come.

**ANS Z83.26-2014 • CSA 2.37-2014 Gas-Fired Outdoor Infrared Patio Heaters**

**ATTACH YOUR RECEIPT HERE**

**Serial Number \_\_\_\_\_ Purchase Date \_\_\_\_\_**



**Questions, problems, missing parts?** Before returning to your retailer, call our customer service department at **1-888-775-1330**, 7 a.m. - 4 p.m., PST, Monday – Friday. Or email us at [warranty@azpatioheaters.com](mailto:warranty@azpatioheaters.com).

# WARNINGS AND CAUTIONS

Read the instruction before use. This appliance must be installed in accordance with such regulations as are enforced.

## CAUTION

**Installer:** Leave the manual with the user for future use.  
**Consumer:** Please keep this manual for future reference.

## DANGER

### IF YOU SMELL GAS:

- Shut off gas to the appliance.
- Extinguish any open flame.
- If odor continues, keep away from the appliance and immediately call your gas supplier or fire department.

## DANGER

### CARBON MONOXIDE HAZARD

This appliance can produce carbon monoxide, which has no odor.

Using it in an enclosed space can cause injury or death. Never use this appliance in an enclosed space such as a camper, tent or building.



## WARNING

Do not try to light this appliance without reading the “LIGHTING” instructions section of this manual.

Do not store or use gasoline or other flammable liquids or vapors in the vicinity of this or any other appliance. An LP cylinder not connected for use must not be stored in the vicinity of this or any other appliance. If the information in these instruction is not followed exactly, a fire or explosion may result, causing property damage, personal injury or death.

## WARNING

**FOR OUTDOOR USE ONLY!**

## WARNING

Improper installation, adjustment, alteration, service or maintenance can cause property damage, injury or death. Read the installation, operating and maintenance instructions thoroughly before installing or servicing this gas appliance.

## WARNING

Never leave fire pit unattended when hot or in use.  
Keep out of reach of children.

# TABLE OF CONTENTS

• Warnings and Cautions.....	1
• Table Of Contents.....	2
• Warnings.....	3-4
• Tools and Parts... ..	5-6
• Assembly.....	7-9
• Lighting Operation.....	10-12
• Maintenance and Storage.....	13-14
• Trouble Shooting.....	15
• Warranty .....	16

## REMINDER

### **BEFORE ASSEMBLY**

Verify that all parts are included with your gas fire pit BEFORE you begin assembly by checking the Parts and Hardware List. For your convenience, some parts may be pre-assembled or attached to heater components.

If some parts are not included, do not attempt to assemble the gas fire pit. Call the free number on the cover page for replacement parts.

Leave hardware installed HALF-TIGHTENED on the gas fire pit during assembly until unit is completely assembled, then finish tightening all hardware installed.

### **YOUR OWNER'S MANUAL**

Keep and store this Owner's Manual for future reference-It contains important instructions and procedures for safety and maintenance.

# Warnings

You must provide propane gas and propane cylinder. Use a standard 20 lb. propane cylinder only.

Use this heater only with a propane vapor withdrawal supply system. See Chapter 5 of the Standard for Storage and Handling of Liquefied Petroleum Gas, ANSI/NFPA 58. Your local library or fire department should have this book.

The pressure regulator and hose assembly supplied with the appliance must be used.

The installation must conform with local codes, or in absence of local codes, with National Fuel Gas Code, ANSI Z223.1.

A dented, rusted or damaged propane cylinder may be hazardous and should be checked by your cylinder supplier. Never use a propane cylinder with a damaged valve connection.

The LP-gas supply cylinder must be constructed and marked in accordance with the U.S.Department of Transportation (D.O.T) Specifications for LP-Gas Cylinders, or the standard for Cylinders, Spheres and Tubes for Transportation of Dangerous Good and Commission, CAN/CSA-B339, as applicable.

The LP-gas supply cylinder must be provided with a cylinder connection device compatible with the connection for the appliance.

The cylinder used must include a collar to protect the cylinder valve.

The LP-gas supply cylinder must be provided with a listed overfill protection device(OPD).

Do not store a spare LP Gas cylinder under or near this appliance.

Never fill the cylinder beyond 80 percent full.

For appliances designed to use a CGA No. 7911 QCC connection:

Place the dust cap on the cylinder valve outlet whenever the cylinder is not in use.

Note: Gas supply pressure: 25 to 250 PS1.

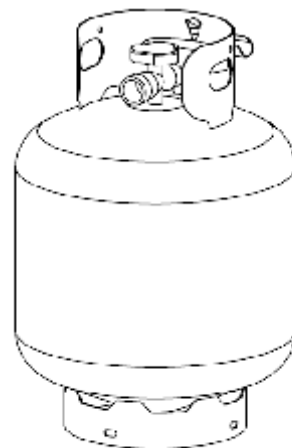

Standard 20 lb. tank

**WARNING** :Fuels used in wood or charcoal burning appliances ,and the products of combustion of such fuels,contain chemicals known to the State of California to cause cancer and birth defects or other reproductive harm.

# Warnings

## NOTE: PLEASE READ THE FOLLOWING SAFETY RULES

### WARNING:

The unit is not for use with solid fuel.

The installation must conform with local codes or, in the absence of local codes, with the National Fuel Gas Code, ANSI Z223.1/NFPA 54, NFPA58 Natural Gas and Propane Installation Code, CSA B149.1, or Propane Storage and Handling CODE, B149.2.

The heater, when installed, must be electrically grounded in accordance with local codes or, in the absence of local codes, with the National Electrical Code, ANSI/NFPA 70, or the Canadian Electrical Code, CSA C22.1.

Prior to use, check for damaged parts such as hoses, regulators, pilot or burner.

Inspect the fuel supply connection for signs of leakage (including the hose for LP models) before each use of the appliance.

All leak tests should be done with a soapy solution. NEVER USE AN OPEN FLAME TO CHECK FOR LEAKAGE.

Children and adults should be alerted to the hazards of high surface temperatures and should stay away to avoid burns or clothing ignition.

Young children should be carefully supervised when they are in the area of the heater.

Clothing or other flammable materials should not be hung from the heater, or placed on or near the heater.

Any guard or other protective device removed for servicing the heater must be replaced prior to operating the heater.

Installation and repair should be done by a qualified service person. The heater should be inspected before use and at least annually by a qualified service person.

More frequent cleaning may be required as necessary. It is imperative that control compartment, burners and circulating air passageways of the heater be kept clean.

Keep the appliance area clear and free from combustible materials, gasoline and other flammable vapors and liquids.

DO NOT OBSTRUCT the flow of combustion and ventilation air.

Keep the ventilation opening(s) of the cylinder enclosure free and clear from debris.







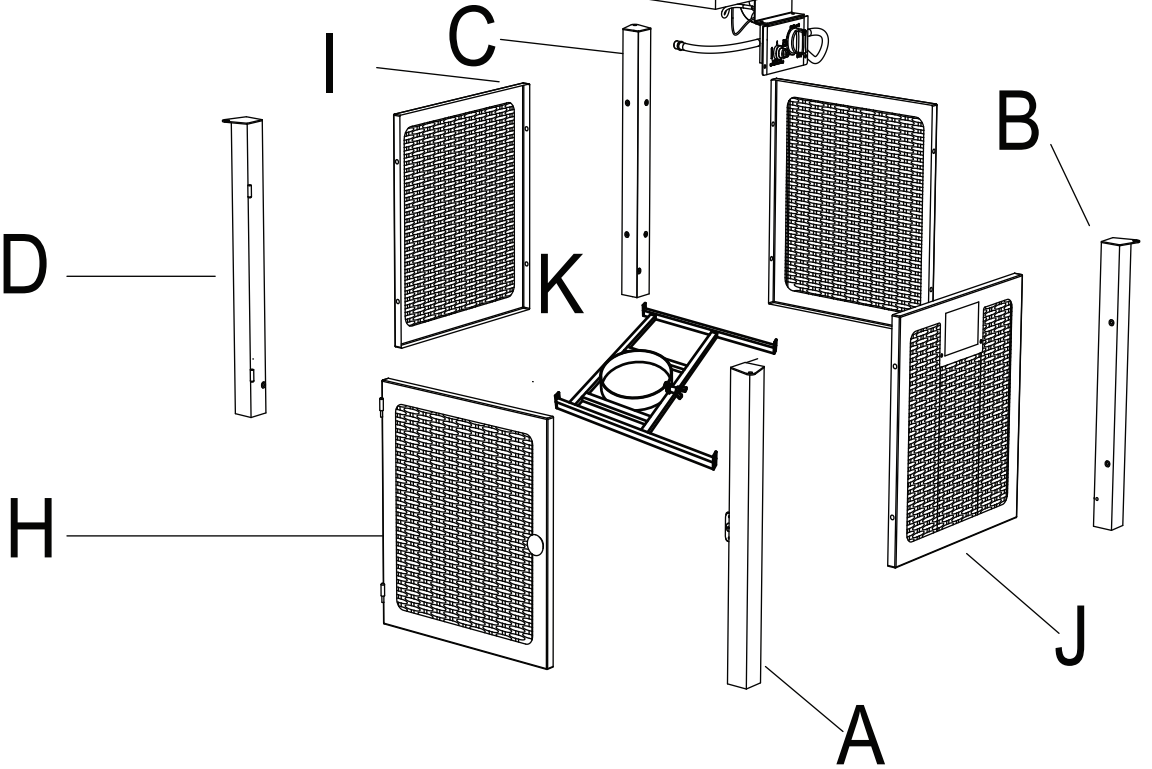
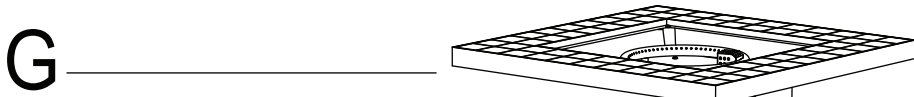

The appliance shall be used only in a well-ventilated space and shall not be used in a building, garage or any other enclosed area.

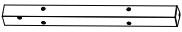
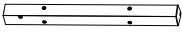
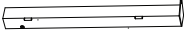
An appliance may be installed with shelter no more inclusive than: With walls on all sides, but with no overhead cover.

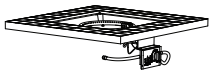



Within a partial enclosure which includes an overhead cover and no more than two side walls. These side walls may be parallel, as in a breezeway, or at right angles to each other.





# Parts List

A	Front Leg		1
B	Back Leg		1
C	Front Leg		1
D	Back Leg		1
E	Cover		1
F	Glass (8.0kgs)		1
G	Table Top With Burner		1
H	Door		1
I	Side Panel		2
J	Side Panel with window		1
K	Gas Tank Support		1
L	Handle		1

# Hardware

AA	M6 X12 bolt		22
BB	M4 X10 bolt		1
CC	M6 Nut		2
DD	Washer		1
EE	AAA Battery		1

# Tools Required (Not included)

1	Adjustable open end wrench	
2	Phillips screwdriver	

# Assembly Instructions

## Step 1:

Connect all four Legs (A,B,C,D) to the Table Top with Burner (G) by using four M6 x12 Bolts (AA).

**NOTE: PLACE TABLE TOP TO NON-ABRASIVE SURFACE.**

**PLEASE DON'T TIGHTEN THE HARDWARE AT THIS TIME.**

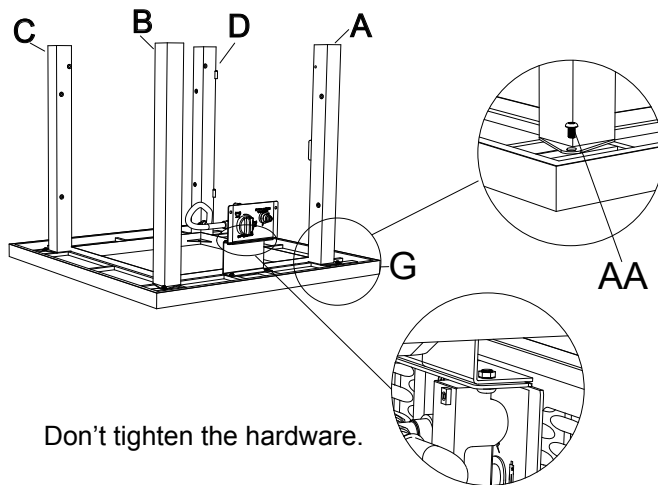

## Step 2:

Connect Side Panel With window (J) to Front Leg (A) and Back Leg (B) by using four M6 x 12 Bolts (AA).

Connect Side Panel (I) to Front Leg (D) and Back Leg (C) by using four M6 x12 Bottls (AA).

Connect Control Panel to Side Panel with Window (J) by using two M6 x12 Bolts (AA) and two M6 Nuts (CC).

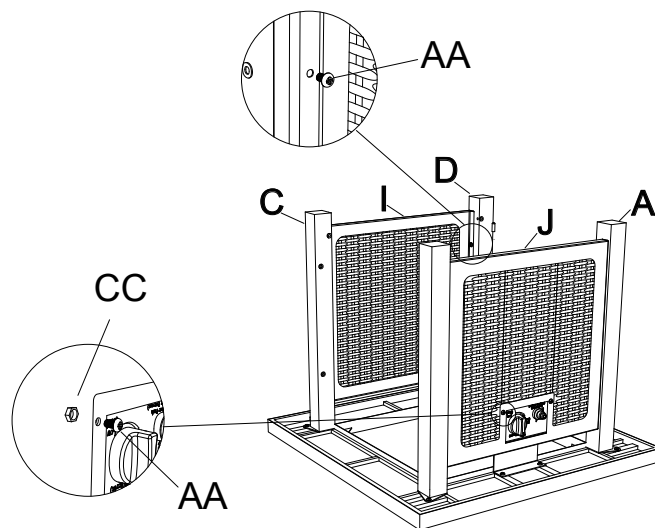

## Step 3:

Connect Side Panel (I) to Back Leg (C) and Back Leg (B) by using four M6 x12 Bolts (AA).

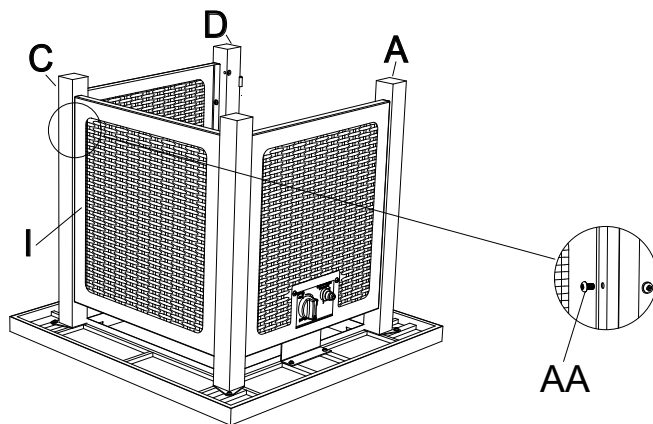



# Assembly Instructions

## Step 4:

Connect Gas Tank Support (K) to the semi-assembled body by using four M6x12 Bolts(AA).

**NOTE: PLEASE TIGHTEN THE HARDWARE AT THIS TIME.**

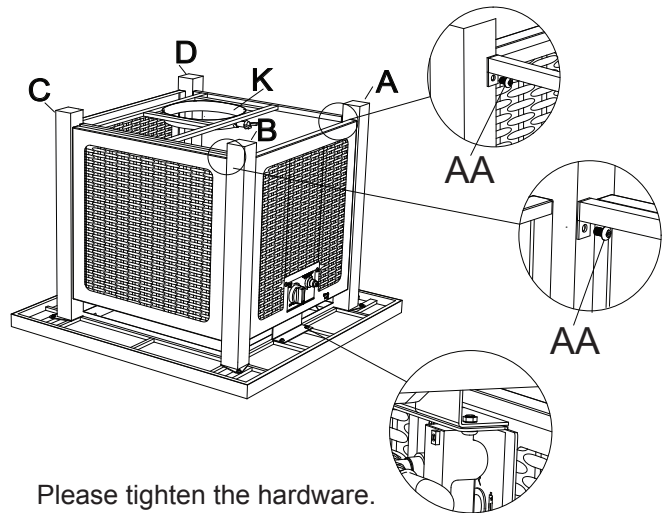

## Step 5:

Connect Door (H) to Front Leg (D) by inserting the door pin into the leg hinge as depicted in graphic

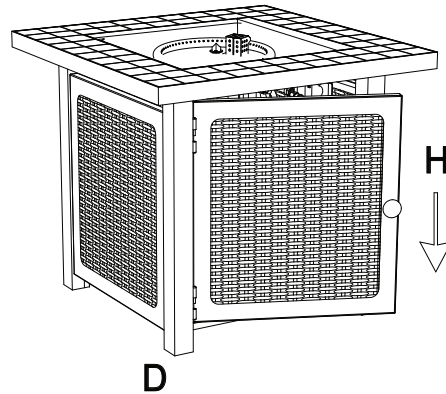

## Step 6:

Connect Handle(L) to Cover (E) by using one M4x10 Bolts(BB)and one Washer (DD). Place the Glass (F) into the fire bowl.

**Note: Ensure no lava rock is placed on the ignition portion of the burner.**

Then place the Cover (E) on.

**Note: The cover must be removed when the burner is in operation. Wait until the unit cools before installing the cover.**

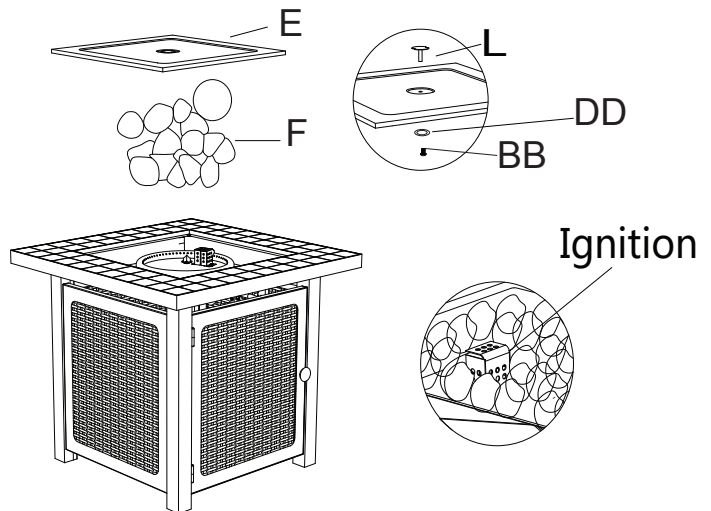

# Assembly Instructions

## Step 7:

Unscrew the igniter counterclockwise and put the AAA battery (EE) in, tighten clockwise.

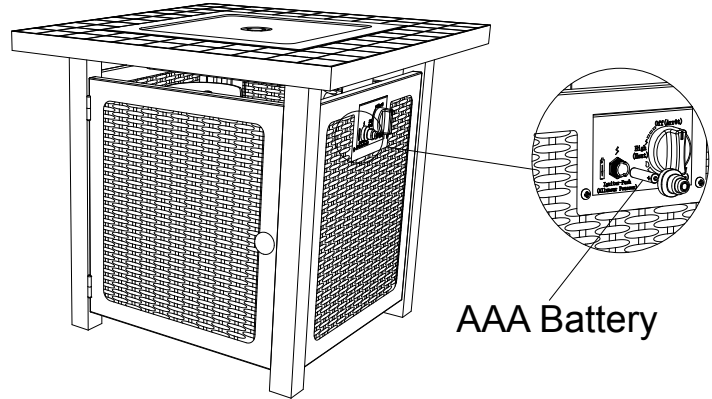

## Step 8:

Put the cylinder into the Gas Tank Support (K), and secure the cylinder by tightening the screw in the gas tank support. Connect the hose and regulator to cylinder.

The propane cylinder is sold separately. Use a standard 20 lbs propane cylinder only.

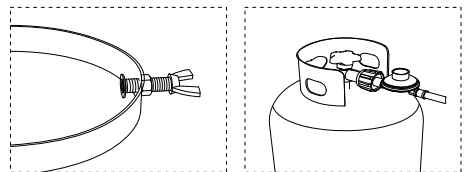
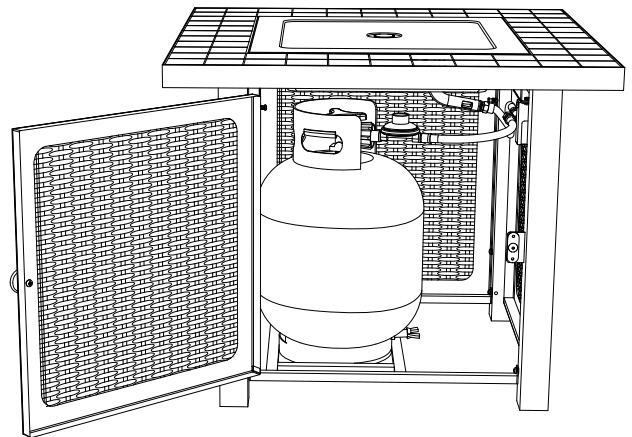

# OPERATION

 **WARNING:** Never use this appliance for other than the intended use. Do not use this appliance to prepare food.

**Initial Lighting:** When lit for the first time, the appliance emits a slight odor. This is normal temporary condition caused by the “burn –in” of internal paints and lubricants used in the manufacturing process and does not occur again. Simply run the main burner on high for approximately one-half hour.

 **WARNING:**

- Children and adults should be alerted to the hazards of high surface temperatures and should stay away from the appliance to avoid burns or clothing ignition.
- Children should be carefully supervised when they are in the area of the appliance.
- Clothing or other flammable materials should not be hung from the appliance, or placed on or near the appliance. The area above the enclosure may be extremely hot. Direct contact with these surfaces should be avoided in order to prevent burns or clothing ignition.
- Any guard or protective device removed for servicing the appliance must be restored prior to operating the appliance.
- Installation and repair should be done by a qualified service person.
- The appliance should be inspected before each use and at least annually by a qualified service person. More frequent cleaning may be required as necessary. It is imperative that the control compartment, burners and circulating air passageways of the appliance be kept clean.

 **WARNING:**

- Never use the appliance while it is raining. Always turn the appliance off when raining.
- Never use the appliance if the burner is damaged. Inspect the burner before each use. Ensure that no debris such as leaves; grass or other objects have entered or are on the appliance. If the burner is damaged it must be replaced prior to using the appliance with a replacement burner specified by your dealer.
- Inspect the hose assembly before each use. If there is evidence of excessive abrasion or wear, or if the hose is damaged, it must be replaced prior to using the appliance with a replacement hose assembly specified by your dealer.

 **WARNING: Any modification to the appliance may compromise the safety of this appliance. Special concern is as follows:**

Do not bypass thermocouple safety.

Do not operate the appliance if any parts has been under water. Immediately call a qualified service technician to inspect the appliance and replace any part of the control system and any gas control, which has been underwater.

# OPERATION

## Leak Testing Operation



**WARNING:** A leak test must be performed annually, or if a part of the gas system is replaced.



**WARNING:** Never use an open flame to check for gas leaks. Be certain no sparks or open flames are in the area while you check for leaks. Sparks or open flames will result in a fire or explosion, damage to property, serious bodily injury, or death.

**Leak testing:** This must be done before initial use, annually, and whenever any gas components are replaced or serviced. Do not smoke while performing this test, and remove all sources of ignition. See Leak Testing Diagram for areas to check. Turn all burner controls to the off position. Turn gas supply valve on. Brush a half-and-half solution of liquid soap and water onto all joints and connections of the regulator, hose, manifolds and valves. Bubbles will indicate a gas leak. Either tighten the loose joint or have the part replaced with one recommended by your dealer and have the appliance inspected by a certified gas installer.

If the leak cannot be stopped, immediately shut off the gas supply, disconnect it, and have the appliance inspected by a certified gas installer or dealer. Do not use the appliance until the leak has been corrected.

### DO NOT USE AN OPEN FLAME.

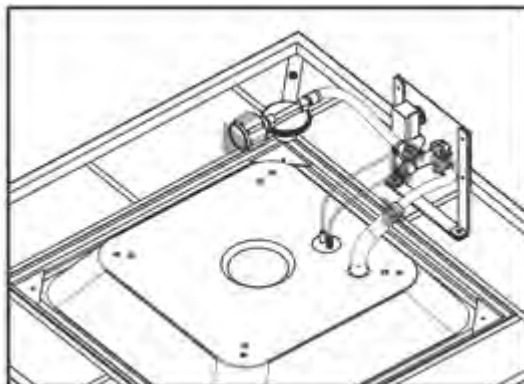
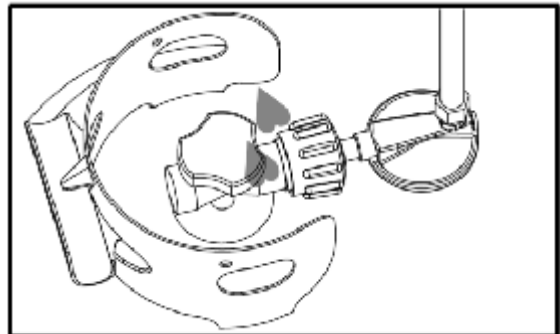
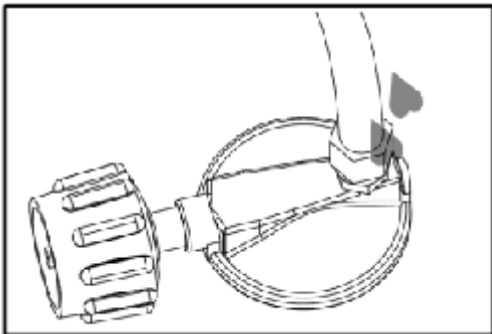

# OPERATION

## Lighting instructions

1. Press and hold electronic igniter button.
2. Turn the burner control to the high position, press and hold in. When the burner lights, release the electronic igniter button.
3. Continue to depress the burner control knob for 30 seconds and then release. If the flame goes out, repeat the procedure.
4. Adjust the flame to the desired height with the burner control knob.
5. If the burner will not light with the electronic igniter, hold a lit long match or lit long butane lighter to the ignition area of the burner and continue with step 2.
6. To shut down the burner turn the burner control knob clockwise to the off position. Then turn the gas off at the source (propane cylinder valve or natural gas supply valve).



### WARNING

#### FOR YOUR SAFETY:

Keep face and body away from burner area when lighting. Ensure burner controls are in the off position. Slowly turn on the gas supply valve.



### WARNING

#### FOR YOUR SAFETY:

The propane cylinder is equipped with an excess flow device. Unless burners are turned off prior to turning the cylinder on, only small flames and low heat will be achievable.



### WARNING

#### FOR YOUR SAFETY:

If the burner does not light within 10 seconds, turn the valve off and wait 5 minutes for any gas to dissipate before repeating the procedure.

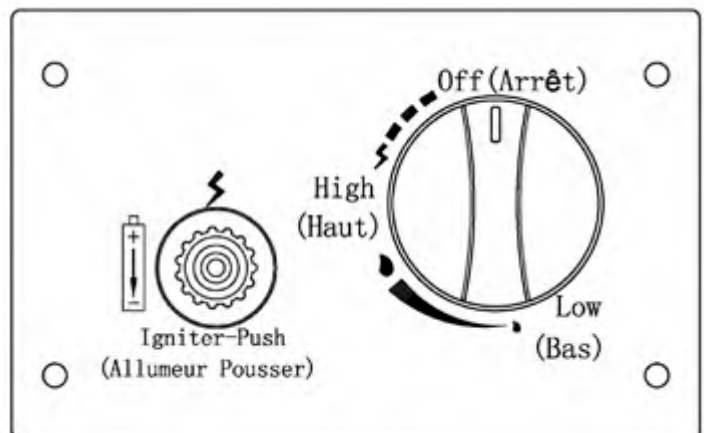

# MAINTENANCE AND STORAGE

## CLEANING AND MAINTENANCE:

To enjoy years of outstanding performance from your heater, make sure you perform the following maintenance activities on a regular basis:

- Keep exterior surface clean.
- Use warm soapy water for cleaning. Never use flammable or corrosive cleaning agents.
- While washing your unit, be sure to keep the area around the burner dry at all times. If the gas control is exposed to water in any way, do NOT try to use it. It must be replaced.
- Keep the appliance area free and clean from combustible materials, gasoline or other flammable vapors and liquids.
- Visually check burner flames.

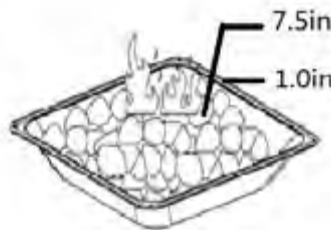

### Normal

- **At least once a year, the unit should be inspected** for the presence of spiders, spider webs or other insects.
- Air flow must be unobstructed. Keep controls, burner, and circulating air passageways clean. Signs of possible blockage include:

Gas odor with extreme yellow tipping of flame.

Heater does NOT reach the desired temperature.

Heater glow is excessively uneven.

Heater makes popping noises.

- Spiders and insects can nest in burner or orifices. This dangerous condition can damage heater and render it unsafe for use. Clean burner holes by using a heavy-duty pipe cleaner. Compressed air may help clear away smaller particles.
- Carbon deposits may create a fire hazard. Clean reflector, thermocouple and emitter screen with a dry cloth if any carbon deposits develop.
- The burner is made from stainless steel, but extreme heat and a corrosive environment can cause surface corrosion to occur. This can be removed with a brass wire brush. Inspect the burner at least annually for cracks, insect nests, excessive corrosion or any other damage. If the burner is damaged, it must be replaced with a burner specified by the manufacturer before the appliance is put into operation.

# MAINTENANCE AND STORAGE

## STORAGE:

### **Between uses:**

- Turn the control knob to “OFF” position.
- Disconnect LP source.
- Store heater upright in an area sheltered from direct contact with inclement weather (such as rain, sleet, hail, snow, dust and debris).
- If desired, cover heater to protect exterior surfaces and to help prevent build up in air passages.

Note: Wait until heater is cool before covering.

### **During periods of extended inactivity or when transporting**

- Turn the control knob to “OFF” position.
- Disconnect LP source and move to a secure, well ventilated location outdoors. DO NOT store in a location that will exceed 125 degrees F.
- Store heater upright in an area sheltered from direct contact with inclement weather (such as rain, sleet, hail, snow, dust and debris).
- If desired, cover heater to protect exterior surfaces and to help prevent build up in air passages.

NOTE: Wait until heater is cool before covering.

# TROUBLE SHOOTING

PROBLEM	PROBABLE CAUSE	SOLUTION
Low heat / Low flame when valve turned to high.	For propane- improper lighting procedure.	Ensure lighting procedure is followed carefully. The valve must be in the off position when the tank valve is turned on. Turn tank on slowly to allow pressure to equalize. See lighting instruction.  Pipe must be sized according to installation code.
Burners burn with yellow flame, accompanied by the smell of gas.	Possible spider web or other debris.	Thoroughly clean burner venturi. See general maintenance instructions.
Burner will not light with the igniter, but will light with a match.	 Move battery / or installed incorrectly.  Loose electrode wire or switch terminal wires.	Replace with heavy duty battery.  Check that the electrode wire is firmly pushed onto the terminal on the back of the igniter. Check that the lead wires from the module to the ignition switch (if equipped) are firmly pushed onto their respective terminals.
Burner will not stay lit when control knob is released.	Knob not being held in long enough.  Too windy.  Lava rock or debris in ignition area of the burner preventing thermocouple from being fully engulfed in flame.  Dirty thermocouple or thermocouple connection.  Faulty thermocouple or valve.	Thermocouple must have time to heat up: hold the knob in for 30 seconds after the burner lights, then release.  Unit will shut down if winds are greater than 10mph (16km/h). Either locate to different area or use when it is less windy.  Ensure there is no lava rock or other debris in ignition area, and that the small hole below the thermocouple is unobstructed.  Clean the thermocouple and clean the connection between the valve and thermocouple. Ensure the connection is properly tightened.  Replace thermocouple and / or valve.
Humming regulator.	Normal occurrence on hot days.	This is not a defect. It is caused by internal vibrations in the regulator and does not affect the performance or safety of the gas heater. Humming regulators will not be replaced.
Burner output on "high" setting is too low. (Rumbling noise and fluttering blue flame at burner surface.)	Lack of gas.  Supply hose is pinched.  Dirty or clogged orifice.  Spider webs or other matter in venturi tube. Propane regulator in "low flow" state.	Check gas level in propane cylinder.  Reposition supply hose as necessary.  Clean burner orifice.  Clean out venturi tube.  Ensure lighting procedure is followed carefully. All valves must be in the off position when the tank valve is turned on. Turn tank on slowly to allow pressure to equalize. See lighting instructions.



## ONE-YEAR LIMITED WARRANTY

---

### CUSTOMERS IN USA

Do not return this product to the store where you purchased it. Please call **1-888-775-1330** for assistance.

### CUSTOMERS IN CANADA

Only return this product to the store if it was purchased within 90 days. If you have problems after 90 days of purchase, please CALL **1-888-775-1330**. **Or email the warranty department at [warranty@azpatioheaters.com](mailto:warranty@azpatioheaters.com)**. DATED PROOF OF PURCHASE REQUIRED FOR WARRANTY SERVICE.

This product is inspected, tested and carefully packaged to minimize the chance of damage during shipment. If a part (excluding light bulbs and fuses\*) within one year from the date of purchase proves to be defective in material or fabrication under normal use, the part will be repaired or replaced. The Company's obligation under the warranty is to replace or repair defective parts at our discretion. Any expenses or damage resulting from the installation, removal or transportation of the product will be the responsibility of the owner and are not covered by this warranty. The owner assumes all other risks arising out from the use or misuse of the product. The warranty will be void if the product damage or failure is deemed by the Company to be caused by accident, alteration, misuse, abuse, incorrect installation or removal, or connection to an incorrect power source by the owner. The Company neither assumes, nor authorizes any person or entity to assume for it any obligation or liability associated with its products.

\* Light bulbs and fuses are not covered under this warranty.

If you have any questions regarding the warranty or service, please call our toll free number: **1-888-775-1330**, or email us at [warranty@azpatioheaters.com](mailto:warranty@azpatioheaters.com).

### **Distributed by:**

AZ Patio Heaters, LLC

Toll Free Number **1-888-775-1330**

Sales Service and Repair

[www.azpatioheaters.com](http://www.azpatioheaters.com)